

Rom 9:30

οὖν

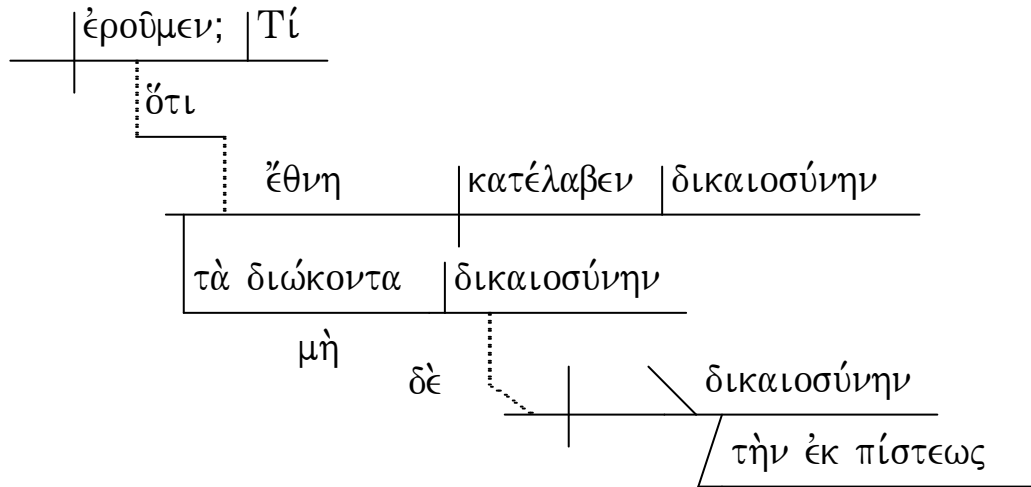

Rom 9:31

δὲ

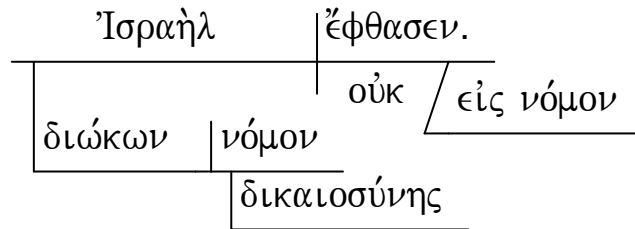

Rom 9:32

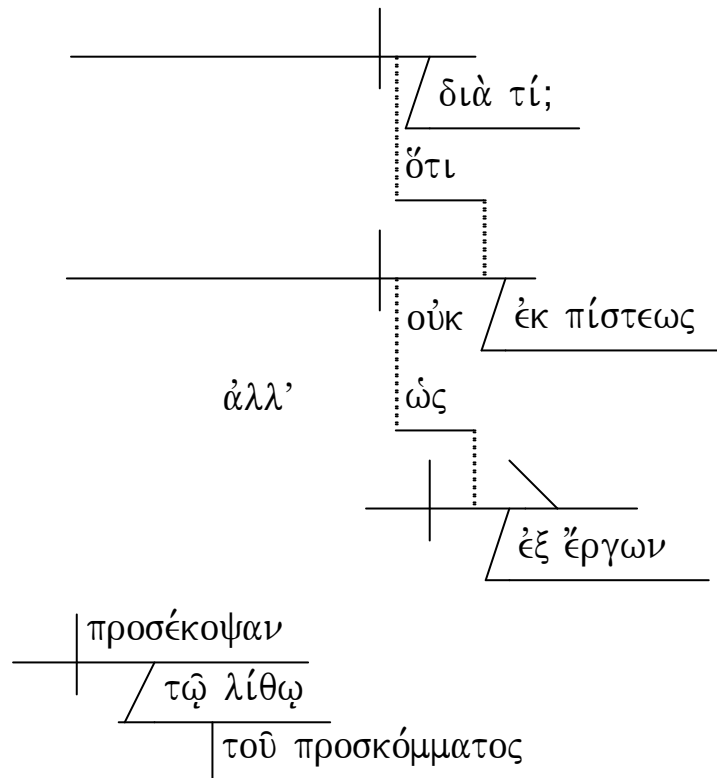

Rom 9:33

καθώς

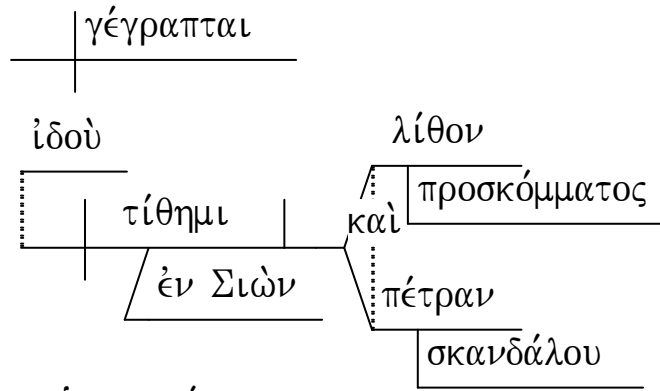

καὶ

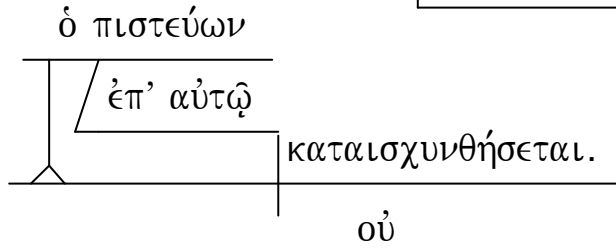

Rom 10:1

μέν

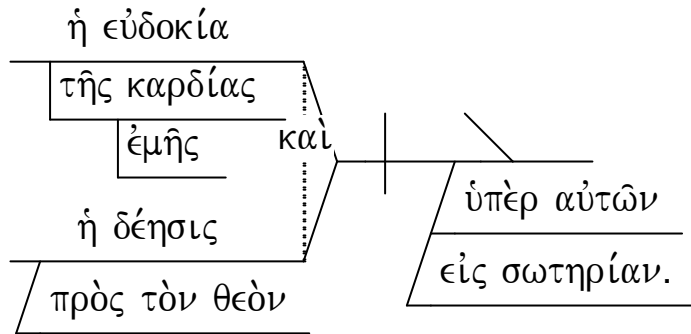

Rom 10:2

γάρ

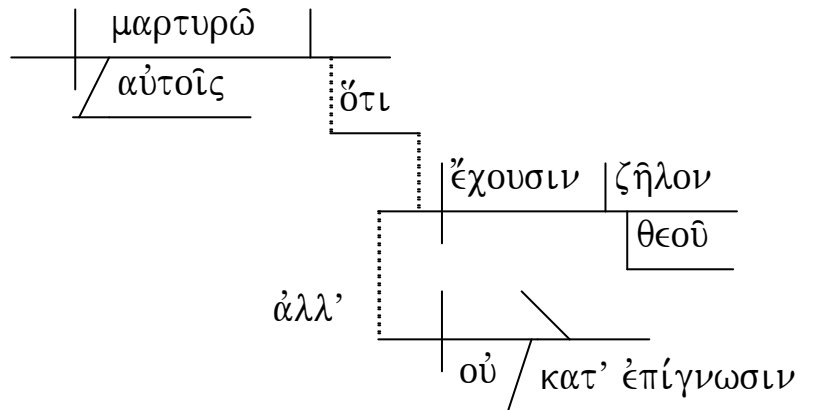

Rom 10:3

γάρ

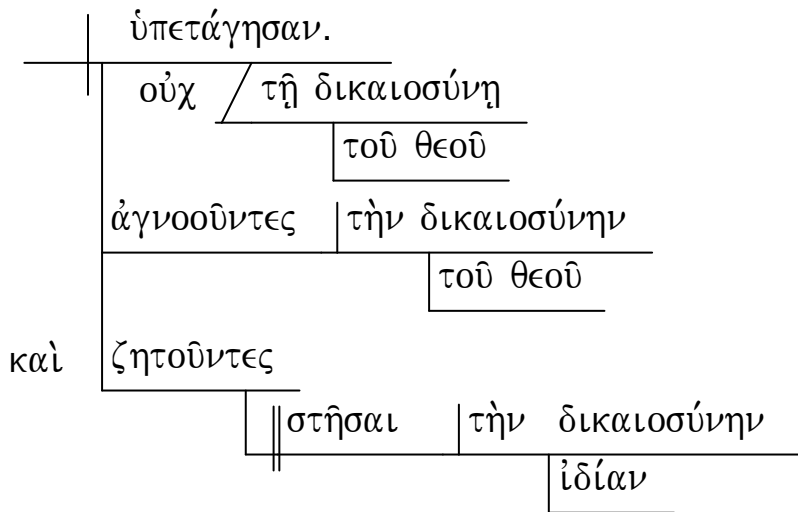

Rom 10:4

γάρ

