

Rev 1:9

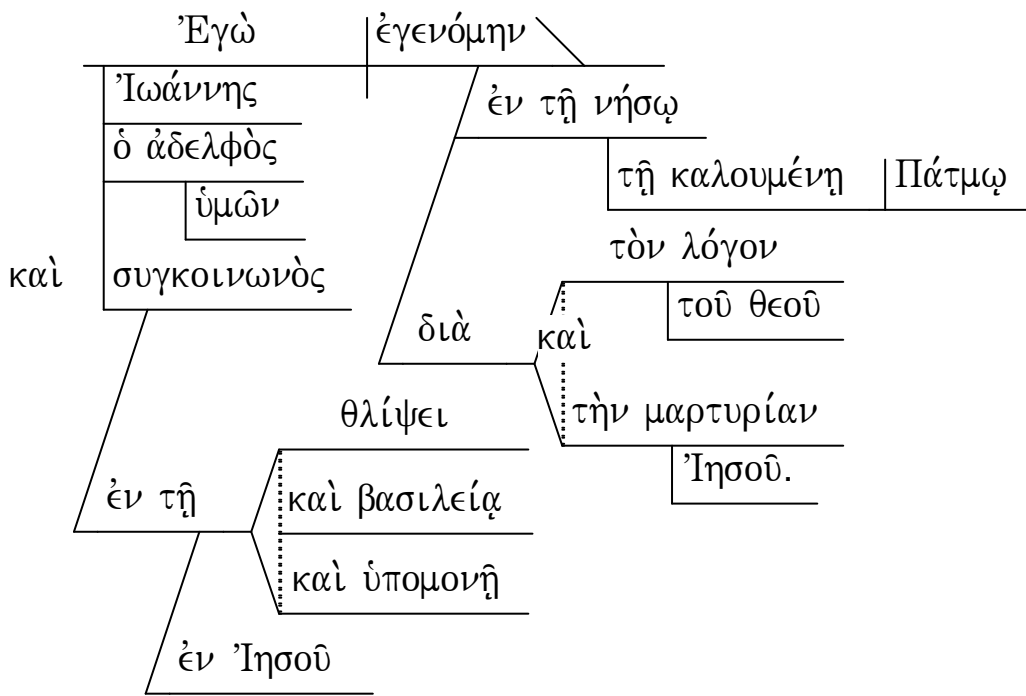

Rev 1:10

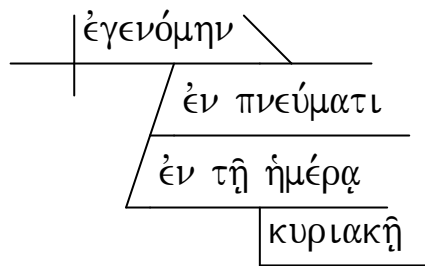

Rev 1:11

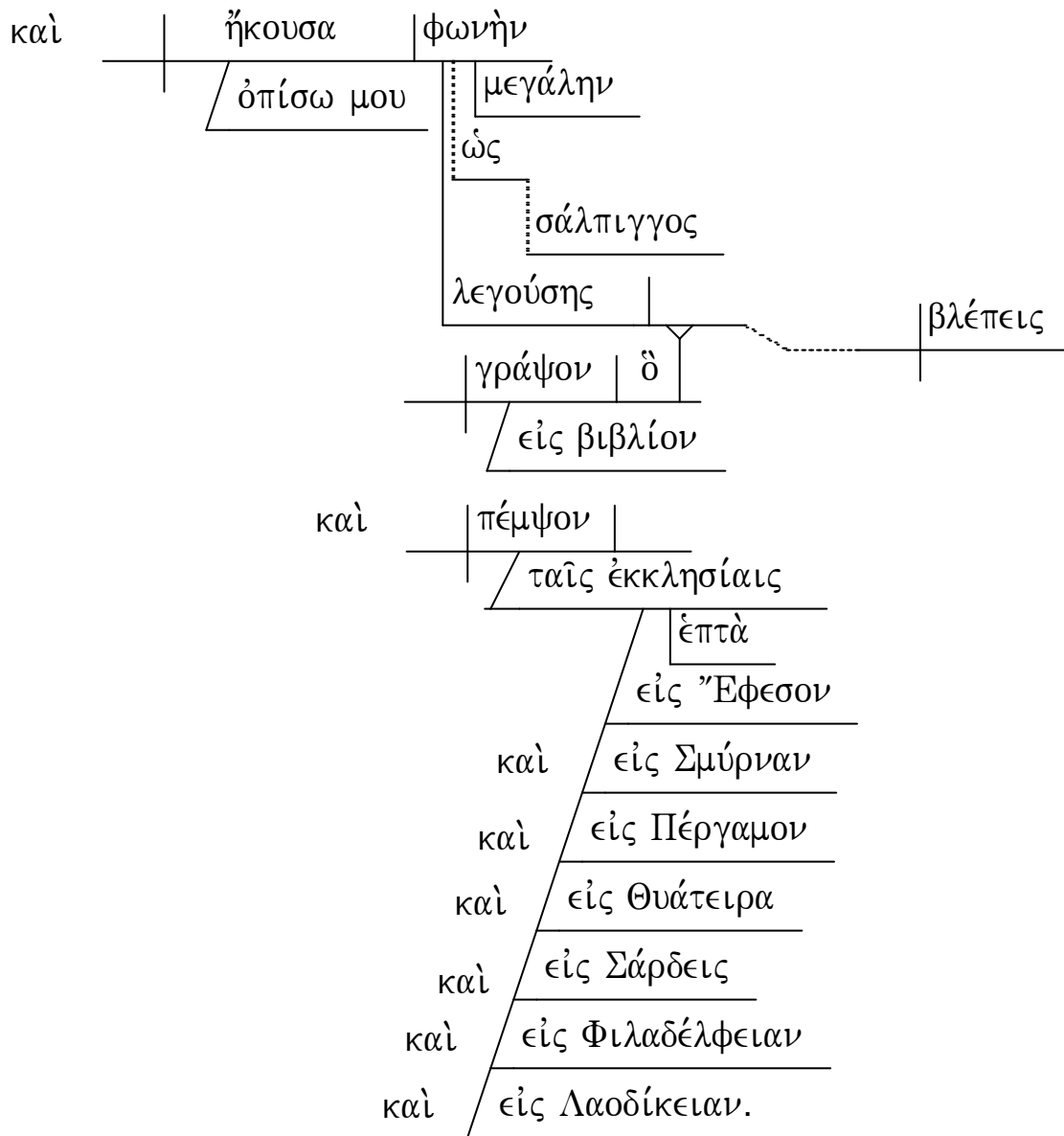

Rev 1:12

Καὶ

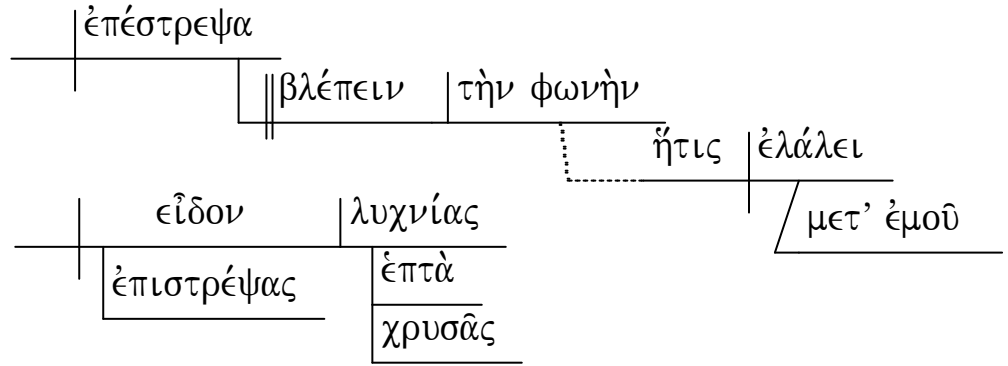

Rev 1:13

καὶ

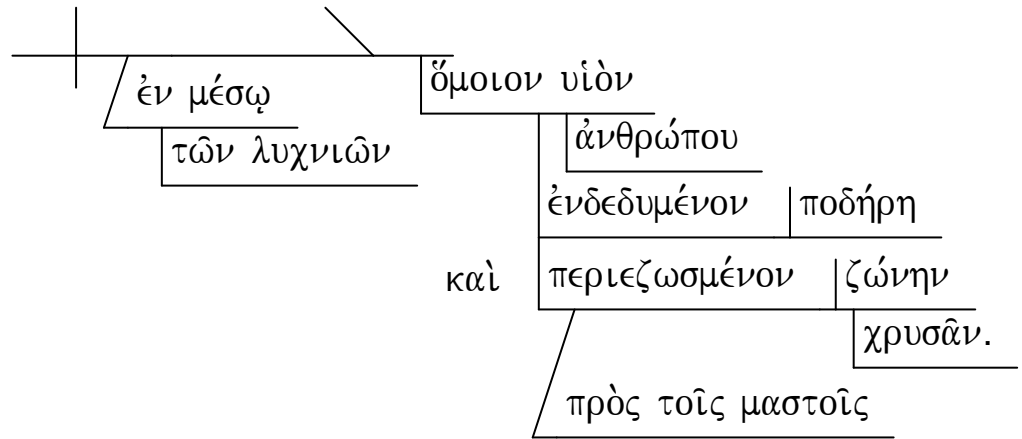

Rev 1:14

δὲ

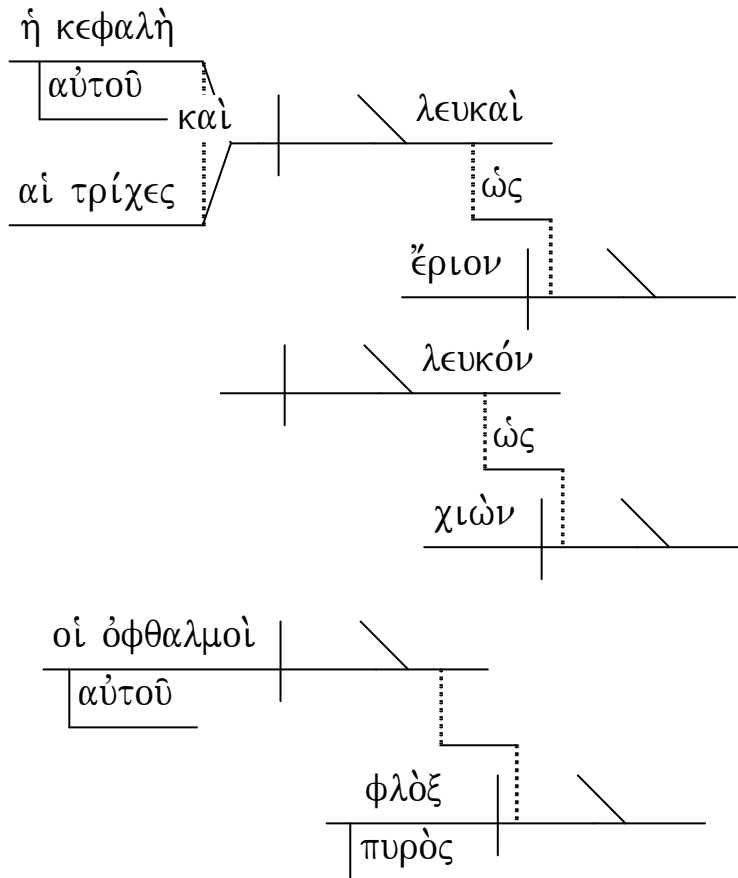

Rev 1:15

καὶ

οἱ πόδες | ὅμοιοι  
αὐτοῦ | ὡς | χαλκολιβάνω  
πεπυρωμένης  
ἐν καμίνω

καὶ

ἡ φωνὴ |  
αὐτοῦ |  
φωνὴ |  
ὕδατων |  
πολλῶν

Rev 1:16

καὶ

ἔχων | ἀστέρας  
ἐν τῇ χειρὶ | ἑπτὰ  
δεξιᾷ  
αὐτοῦ

καὶ

ρομφαία |  
δίστομος | ἔκπορευομένη  
ὀξεῖα | ἐκ τοῦ στόματος  
αὐτοῦ

καὶ

ἡ ὄψις | φαίνει  
αὐτοῦ | ἐν τῇ δυνάμει  
αὐτοῦ.  
ὡς  
ὁ ἥλιος

Rev 1:17

Καὶ

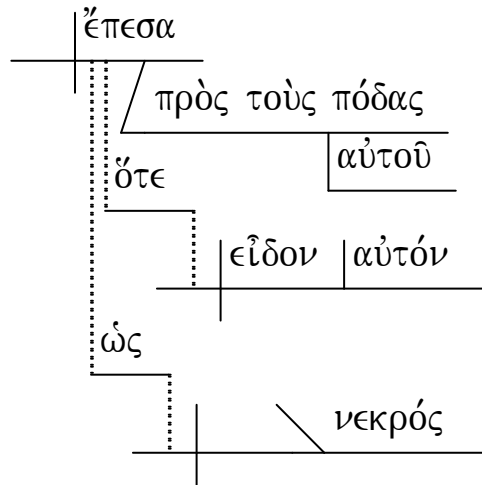

καὶ

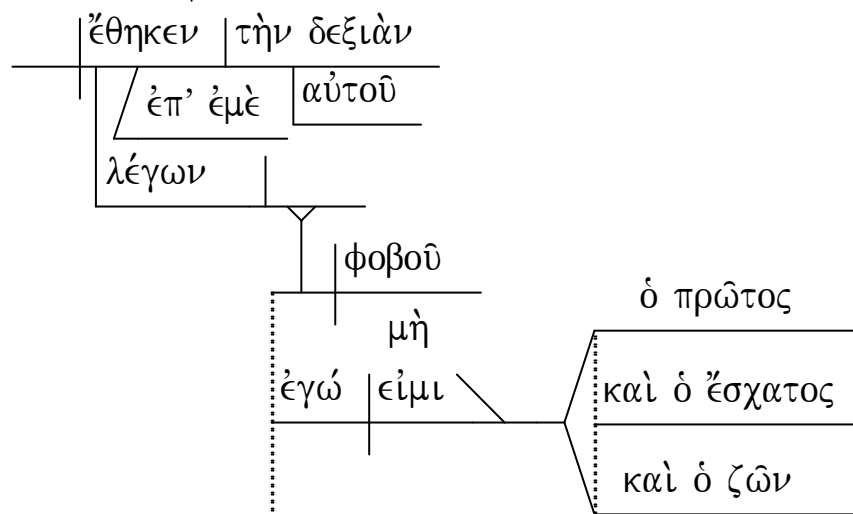

Rev 1:18

καὶ

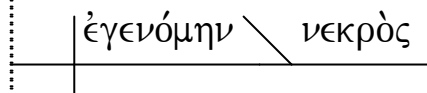

καὶ

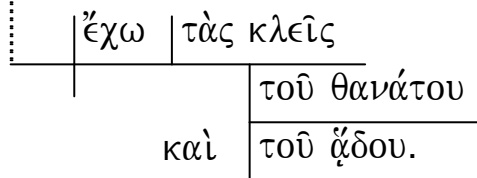
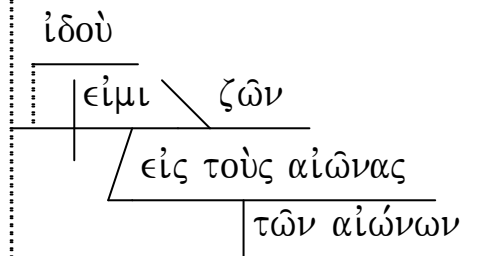

Rev 1:19

οὖν

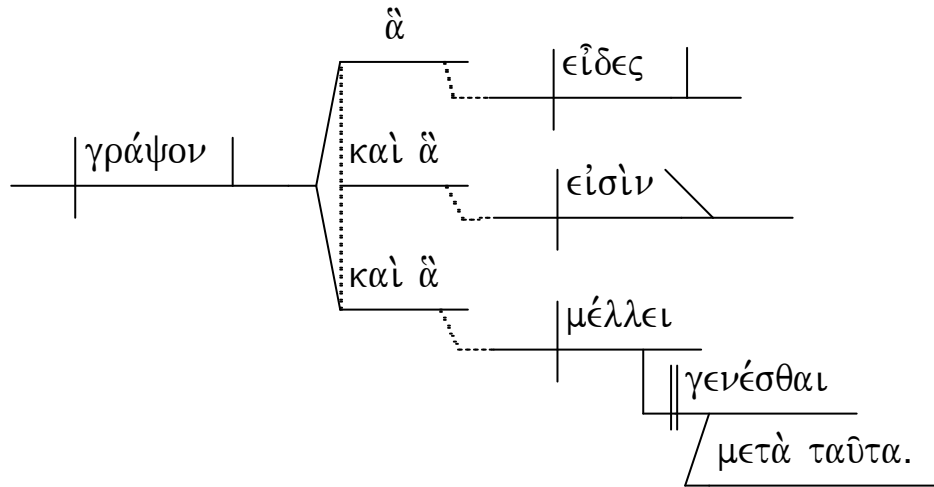

Rev 1:20

