

Luk 12:22

δὲ

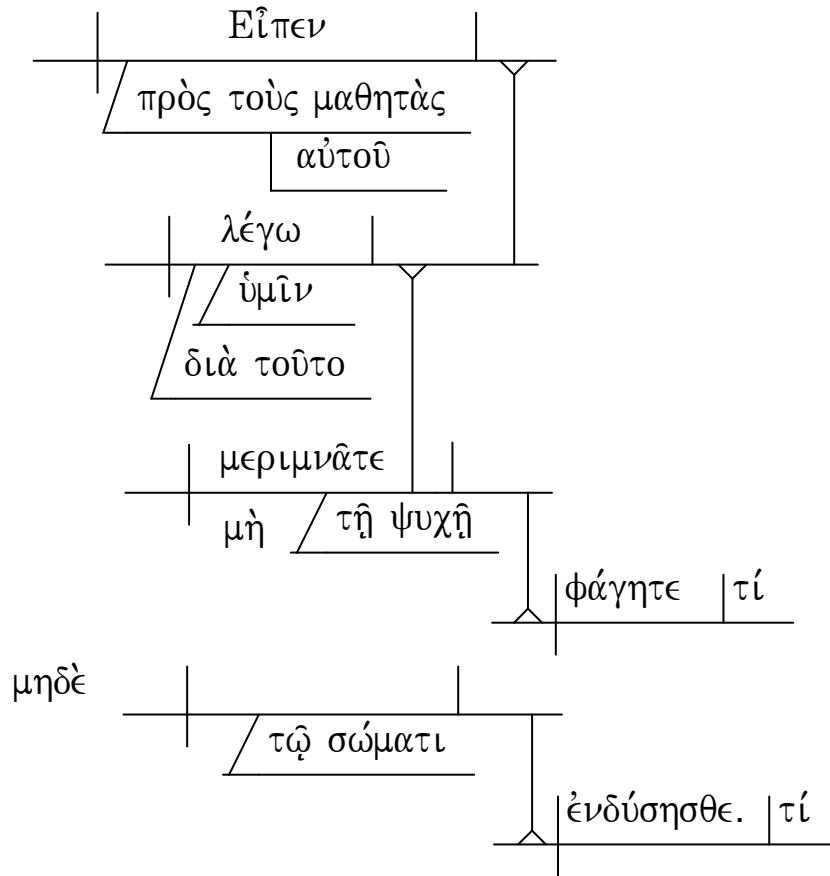

Luk 12:23

γάρ

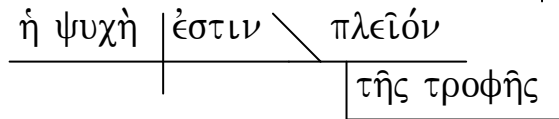

καὶ

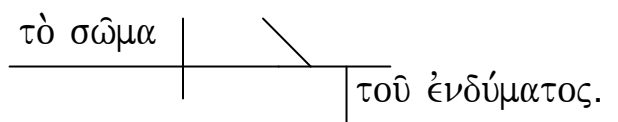

Luk 12:24

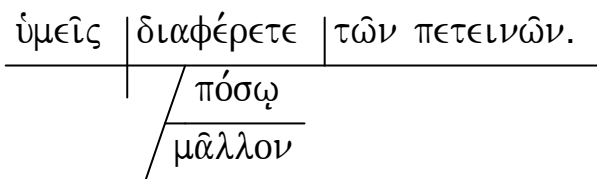
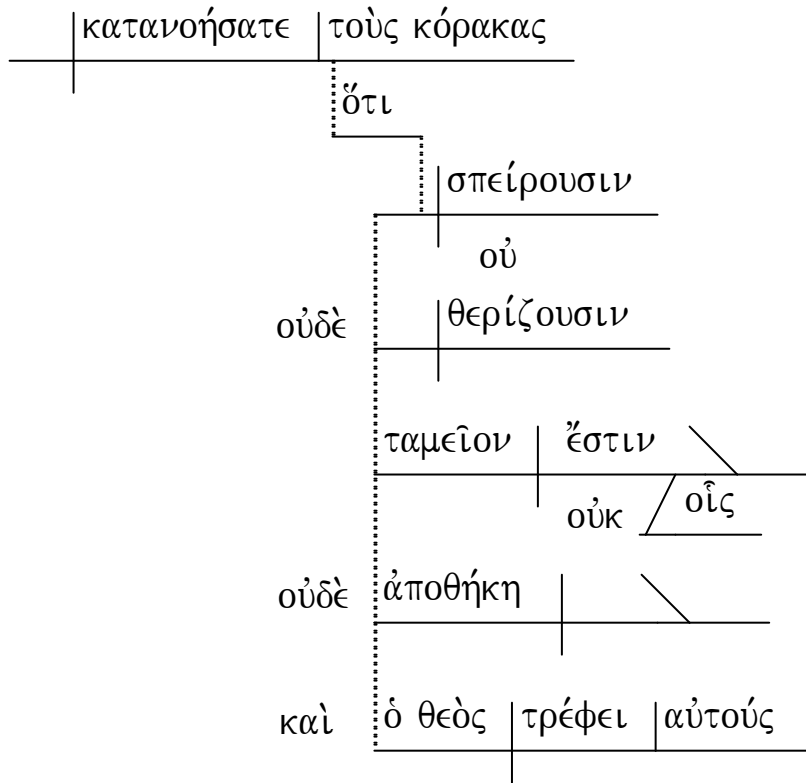

Luk 12:25 δὲ

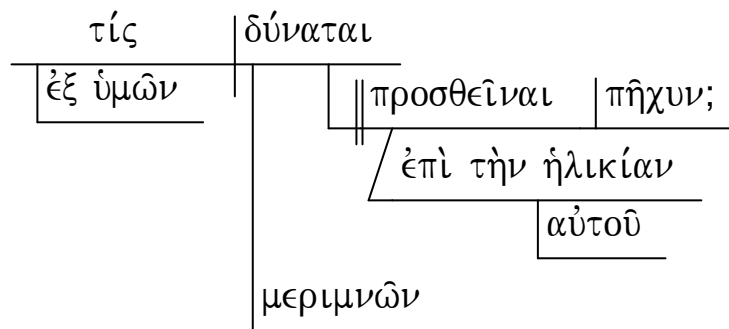

Luk 12:26 οὖν

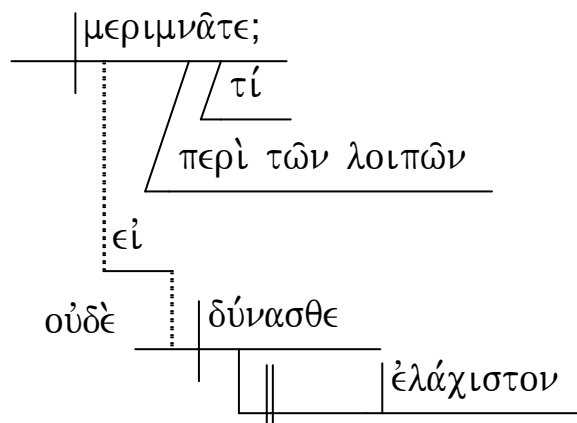

Luk 12:27

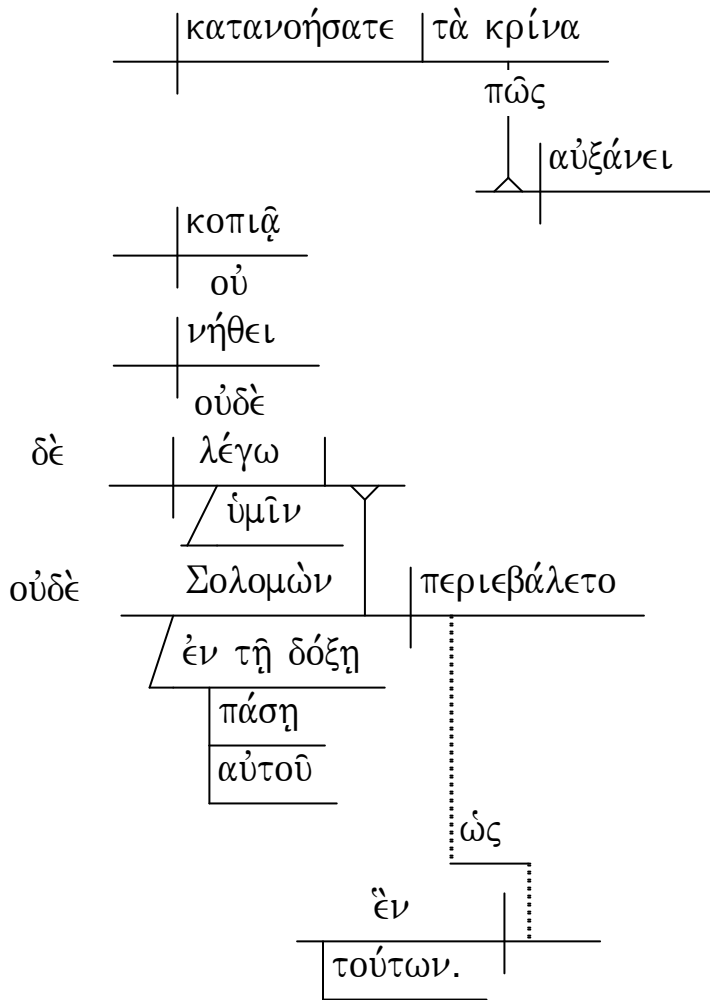

Luk 12:28

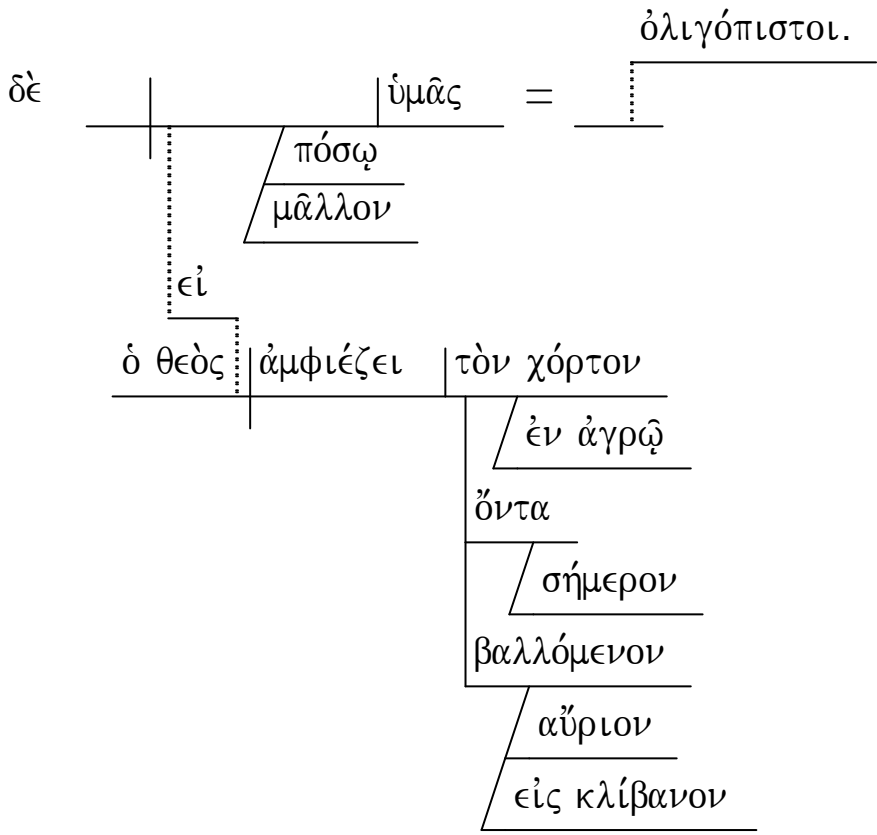

Luk 12:29

καὶ

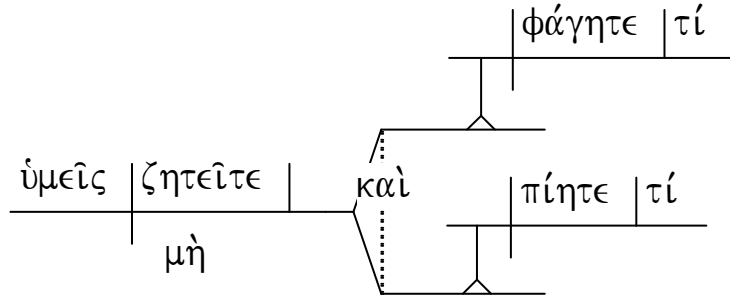

καὶ

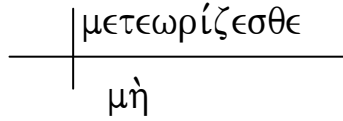

Luk 12:30

γὰρ

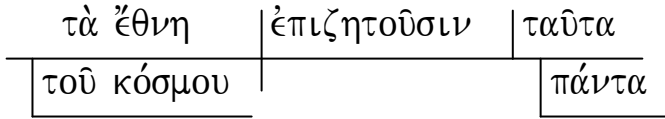

δὲ

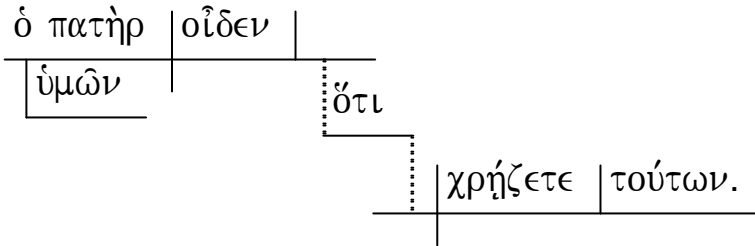

Luk 12:31

πλὴν

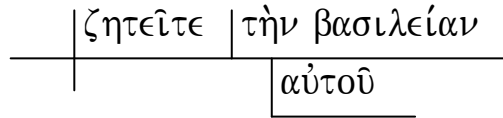

καὶ

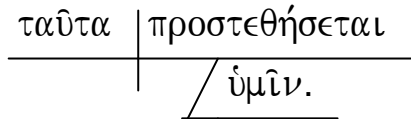

Luk 12:32

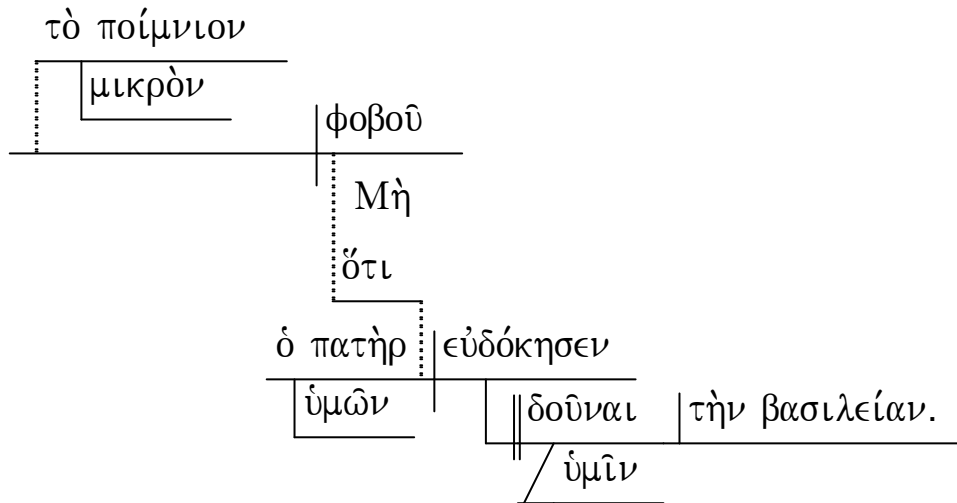

Luk 12:33

Πωλήσατε τὰ ὑπάρχοντα  
ὑμῶν  
καὶ δότε ἐλεημοσύνην  
ποιήσατε βαλλάντια  
ἐαυτοῖς παλαιούμενα  
μὴ  
θησαυρὸν  
ἀνέκλειπτον  
ἐν τοῖς οὐρανοῖς  
ὅπου  
κλέπτῃς ἐγγίζει  
οὐκ  
οὐδὲ σῆς διαφθείρει

Luk 12:34 γάρ ὁ θησαυρὸς ἐστὶν  
ὑμῶν ὅπου

καὶ ἡ καρδία ἔσται.  
ὑμῶν ἐκεῖ