

2Th 3:6 δὲ ἀδελφοί

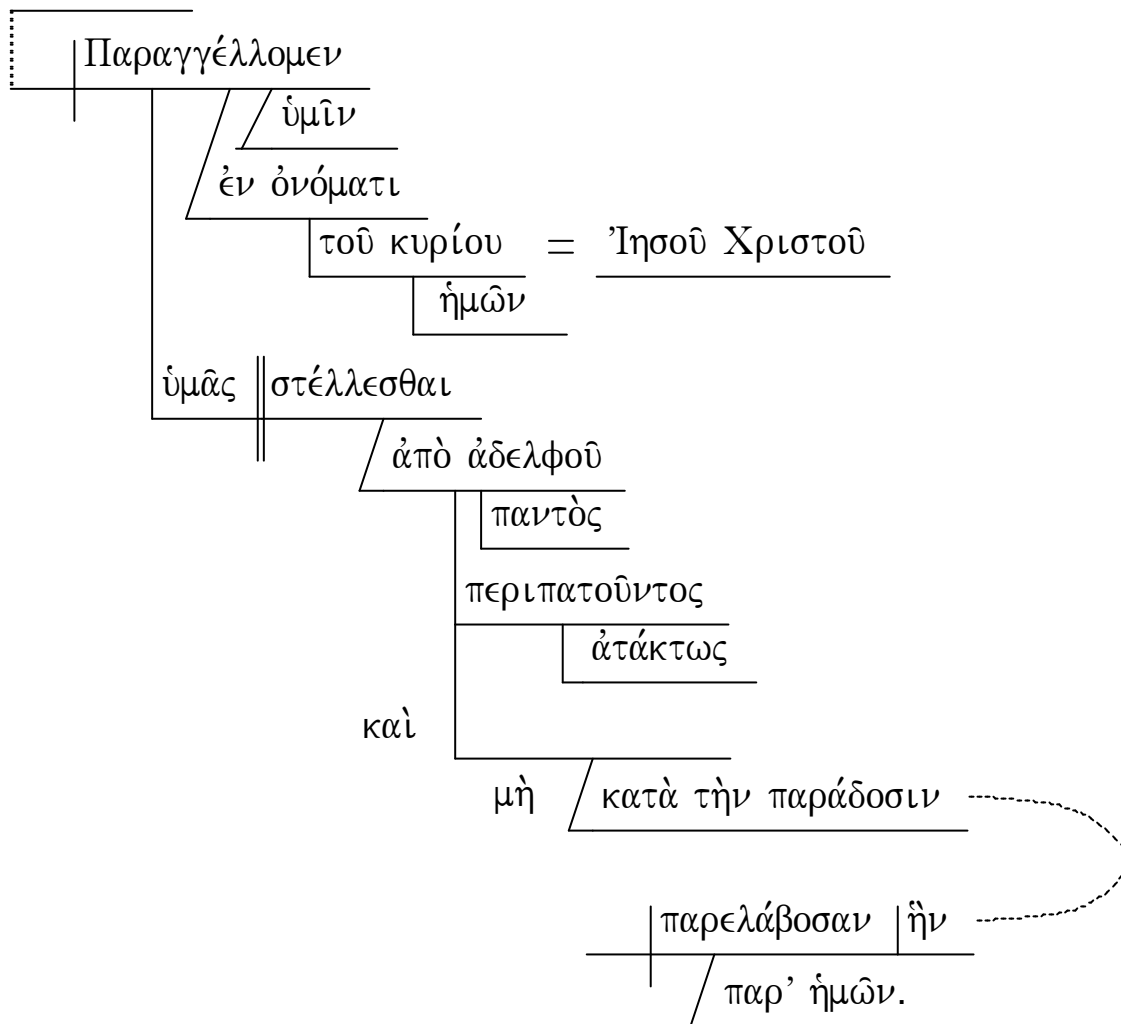

2Th 3:7 γὰρ

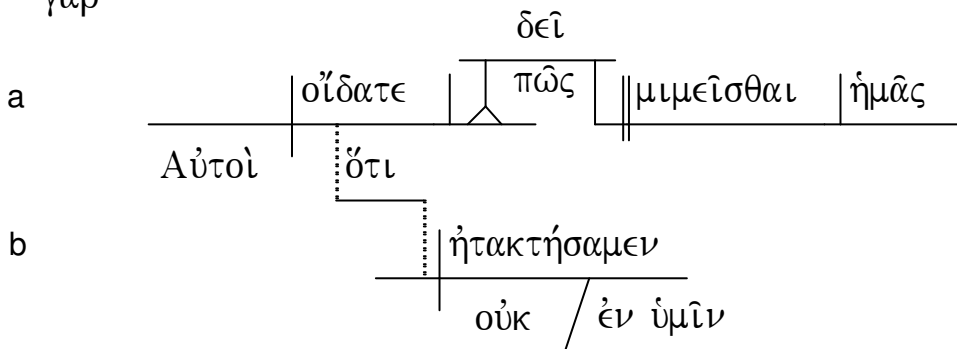

2Th 3:8 a οὐδὲ

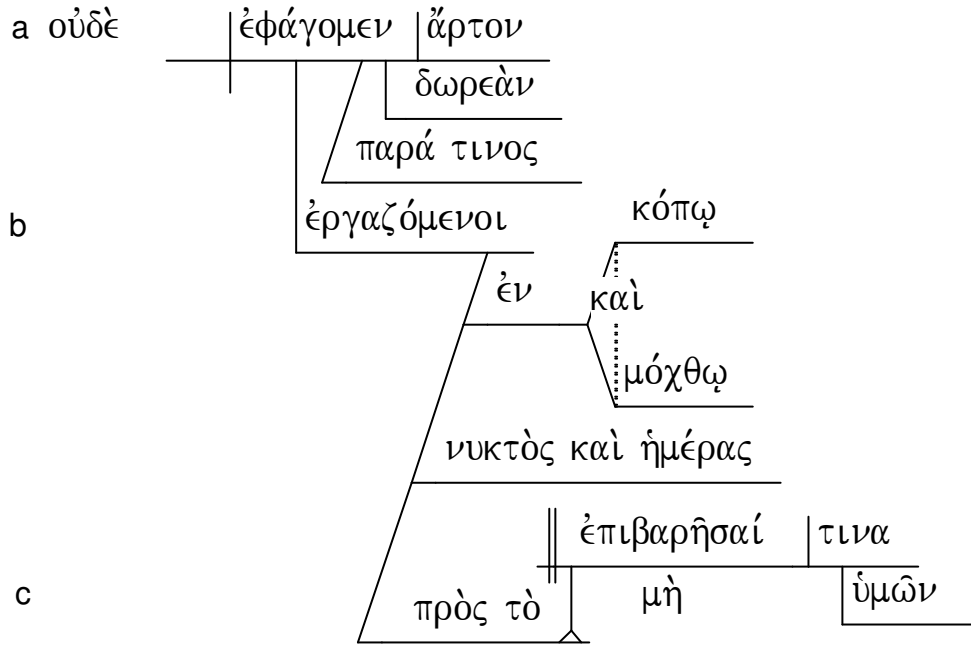

2Th 3:9 a

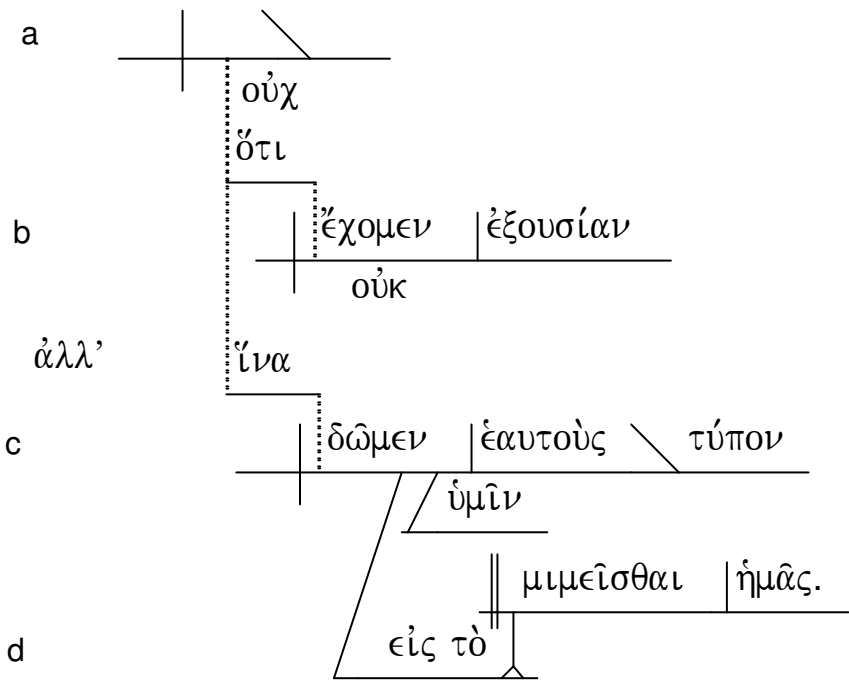

2Th 3:10 b καὶ  
γὰρ

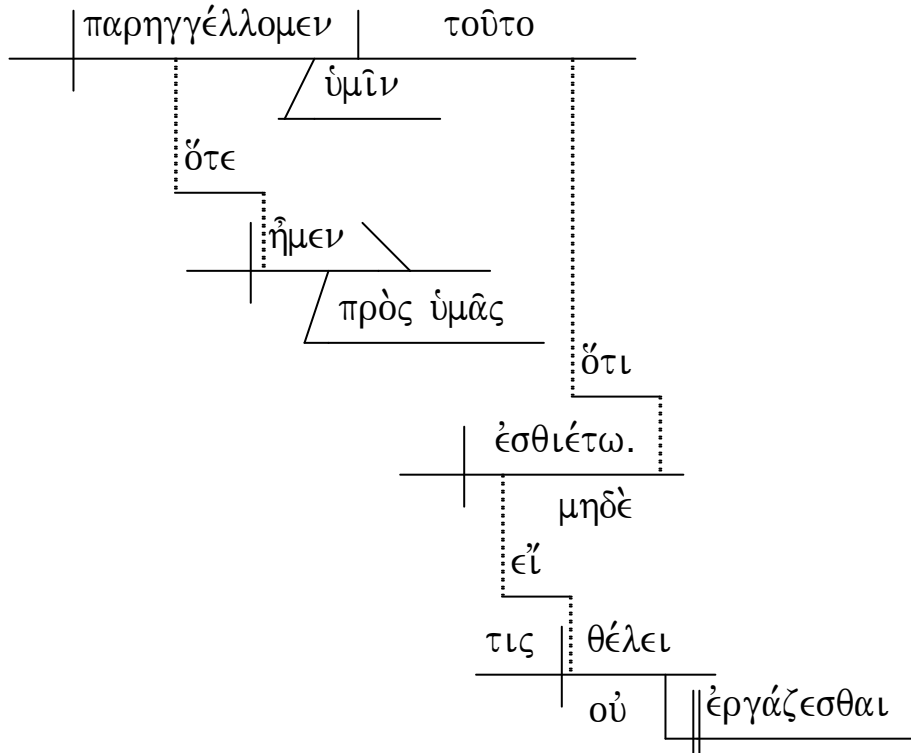

2Th 3:11 a γὰρ

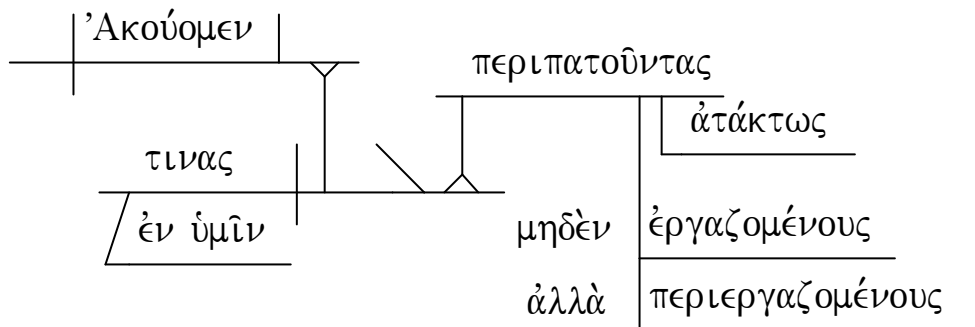

2Th 3:12 a

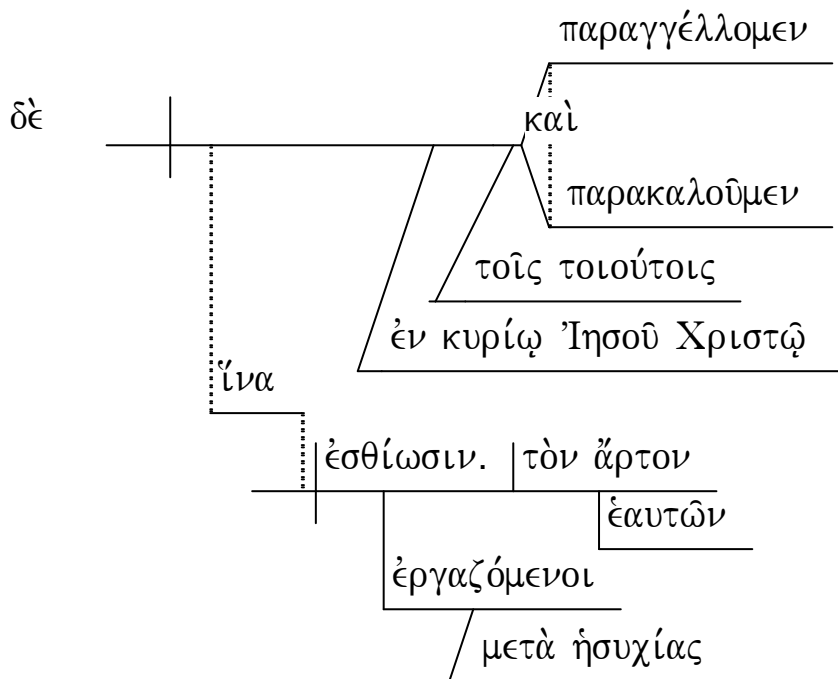

**2Th 3:13** δέ ἀδελφοί

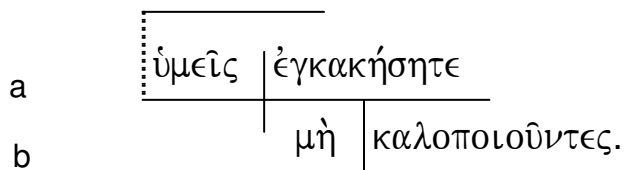

**2Th 3:14** b δέ

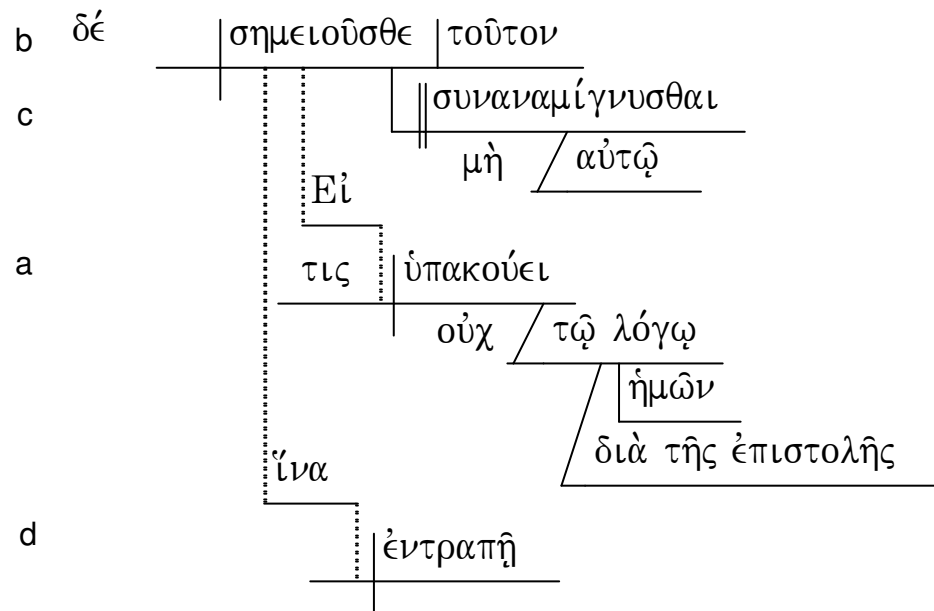

**2Th 3:15** b καὶ

